

LEPANTO I 0029

Designed for KELVIN GIORMANI

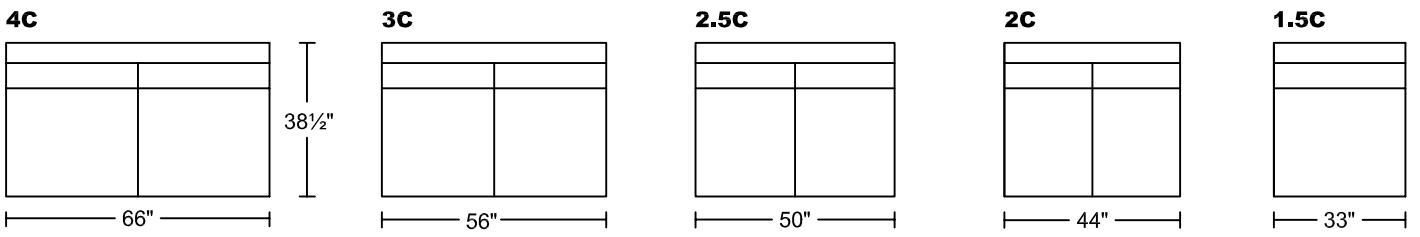
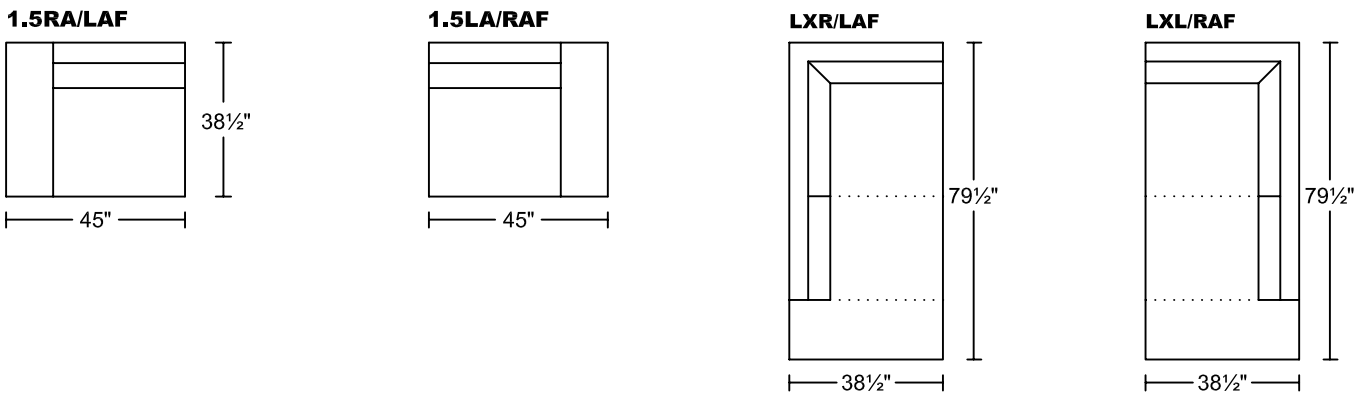
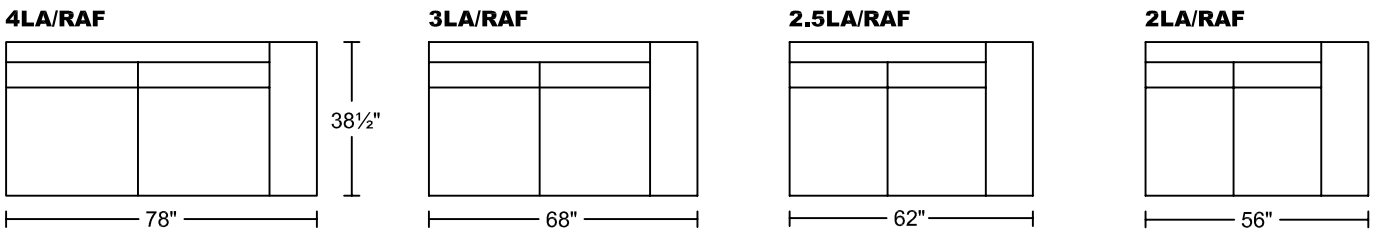
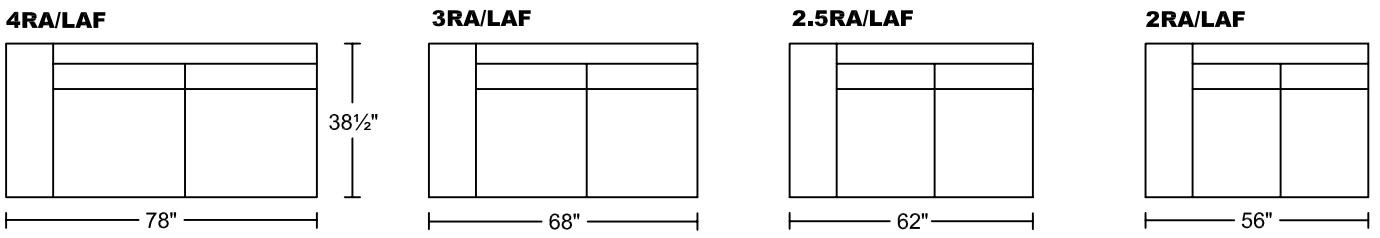
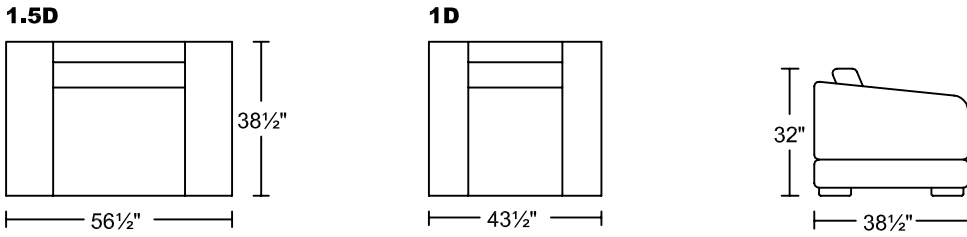
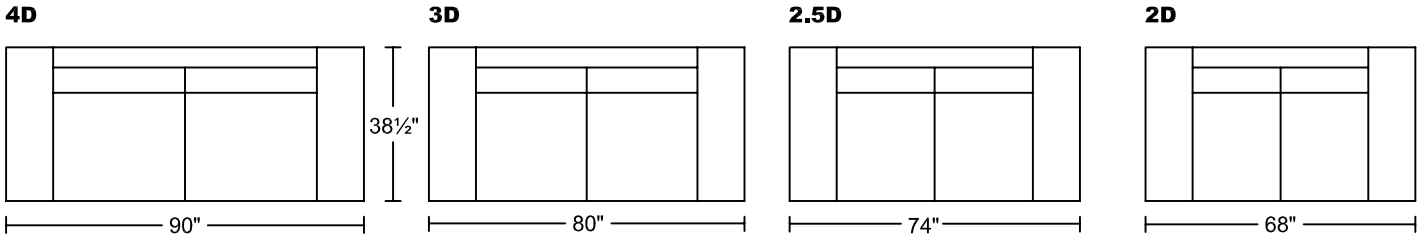
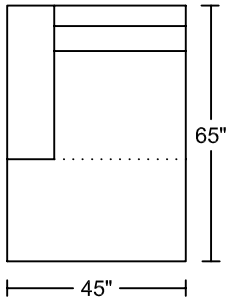

LEPANTO I 0029
Designed for KELVIN GIORMANI

SXR/LAF



SXL/RAF

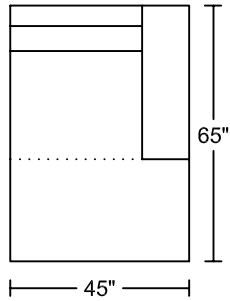

3NR

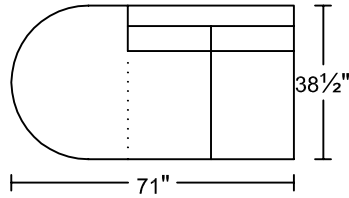

3NL

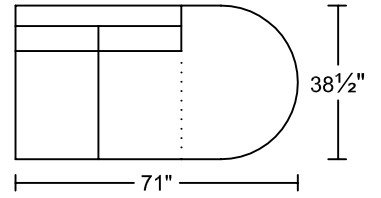

CNB

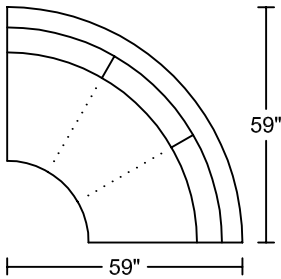

CN

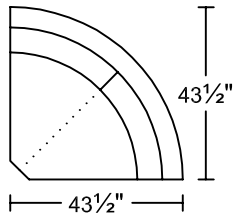

2NR

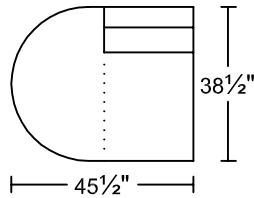

2NL

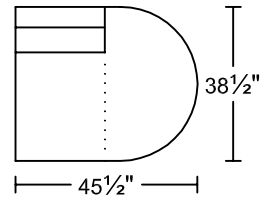

**RTG2
RTW2**

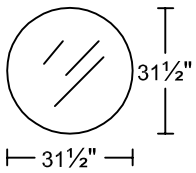

**RTG2
RTW2**

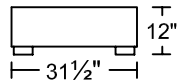

AT3

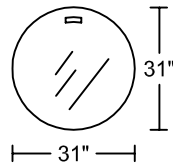

RT2

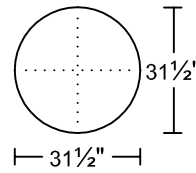

RT2

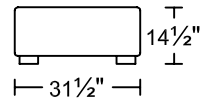

**STG2
STW2**

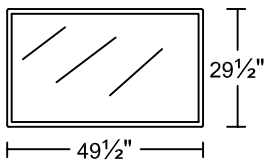

**STG2
STW2**

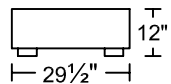

ST2

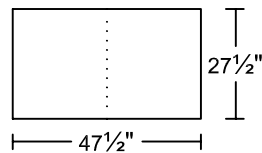

ST2

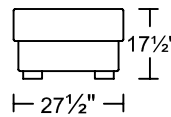

**STG3
STW3**

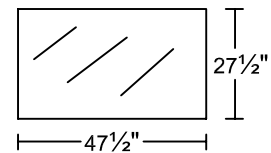

**STG3
STW3**

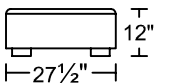

AT2

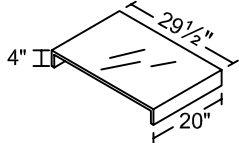

HR2

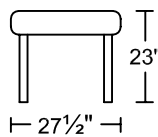

HR1

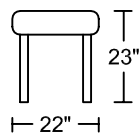

ST

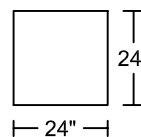

ST

