

MELARA I 0100

Designed for KELVIN GIORMANI

4D

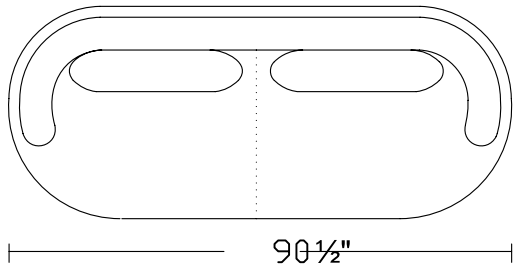

3D

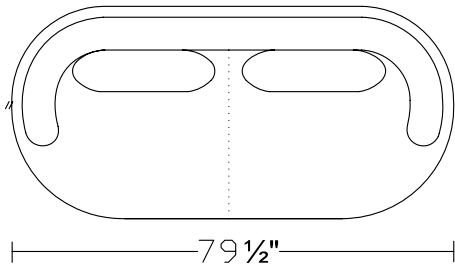

2D

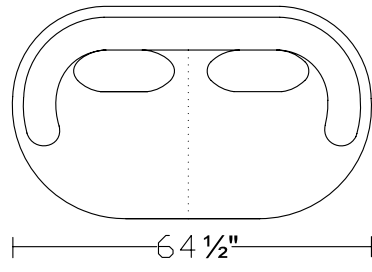

1.5D

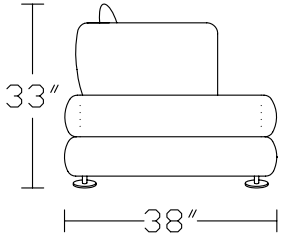
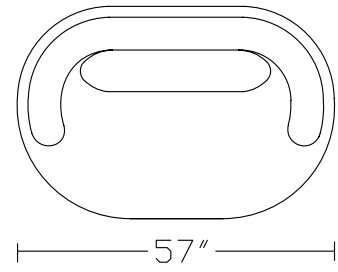

C1DV

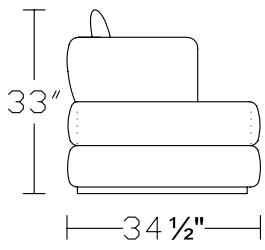
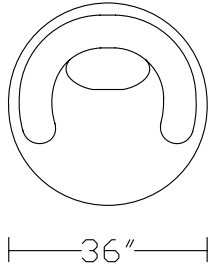

4RA

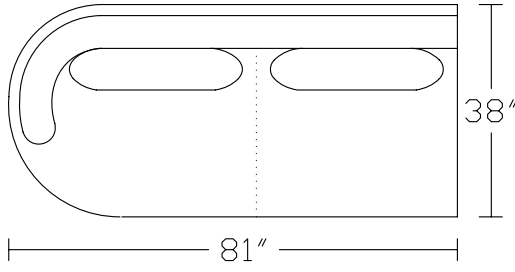

3RA

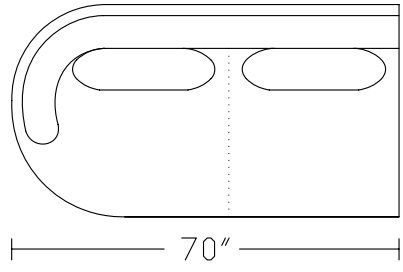

2RA

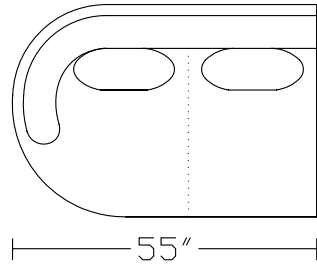

1.5RA

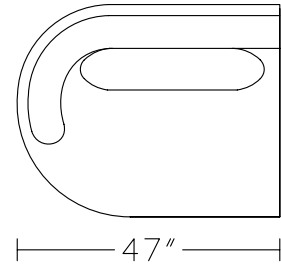

4LA

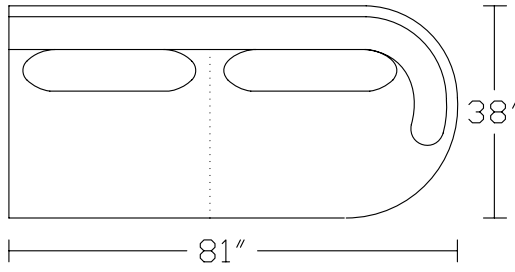

3LA

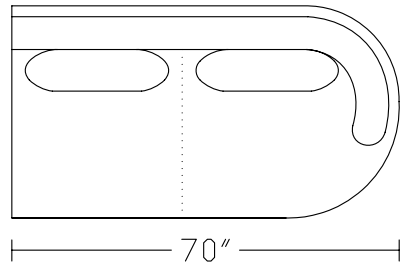

2LA

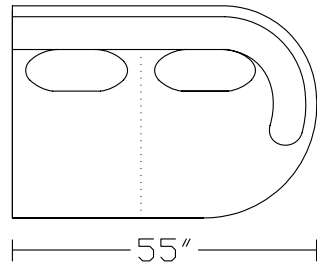

1.5LA

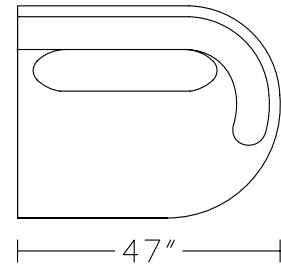

SXR

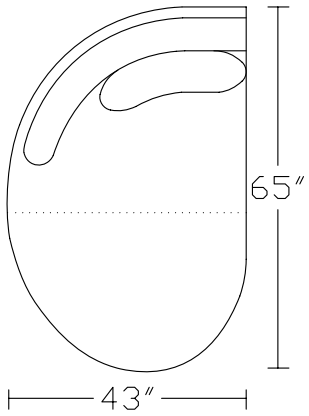

SXL

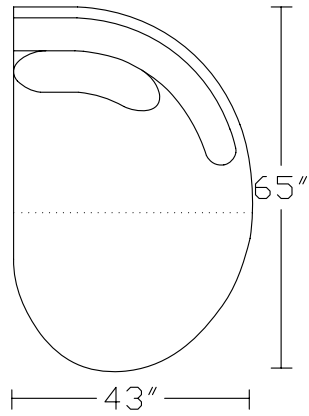

CN

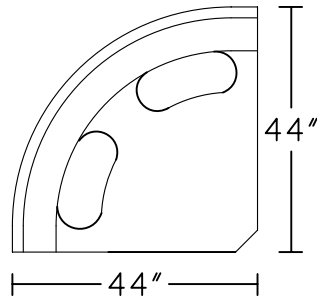

HR

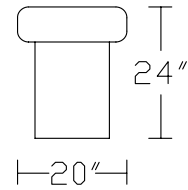

ST

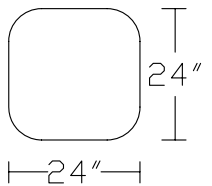

ST

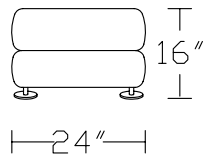

ST2

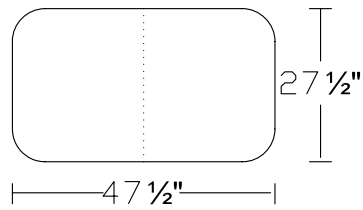

ST2

