

FRECCIA I 0541A-M1

Designed by Kelvin Ng

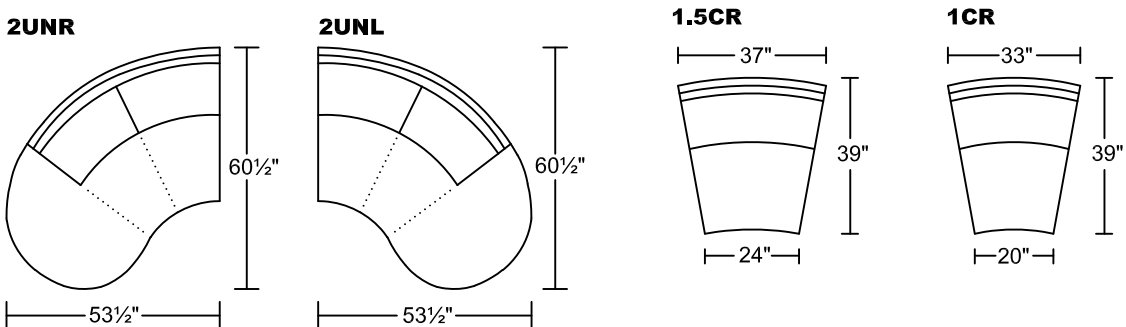
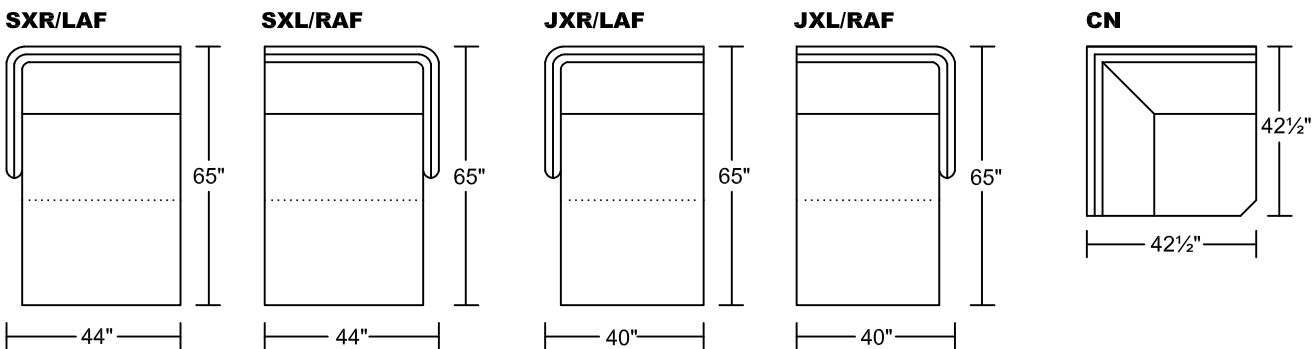
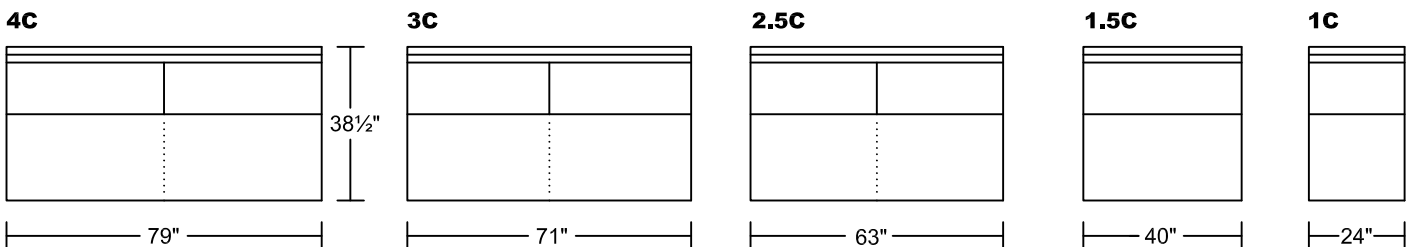
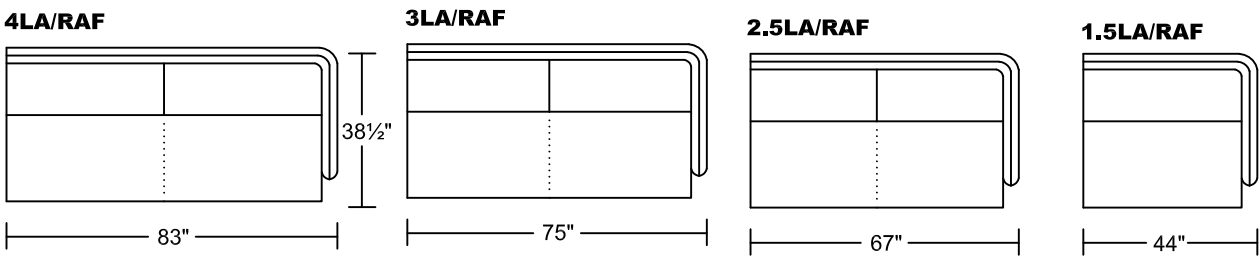
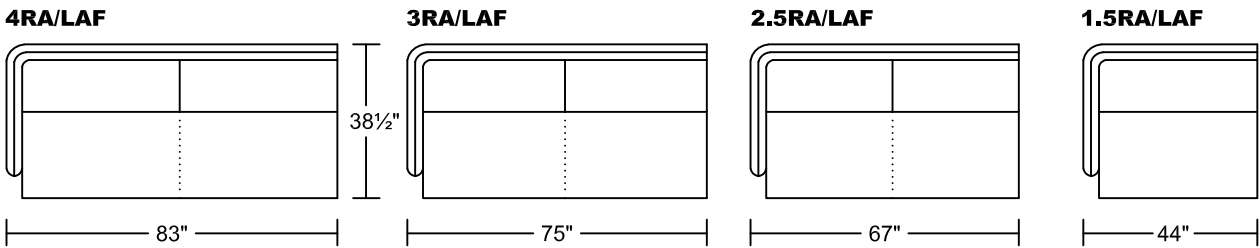
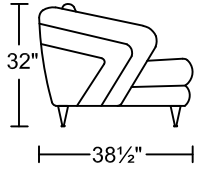
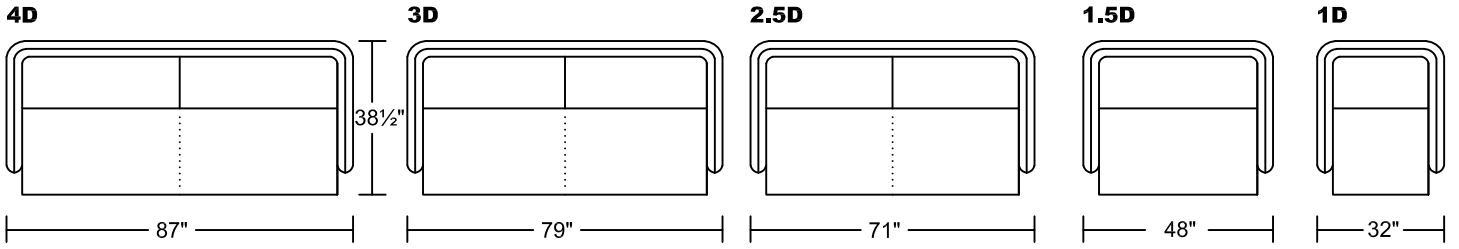

FRECCIA I 0541A-M1

Designed by Kelvin Ng

4BR/LAF

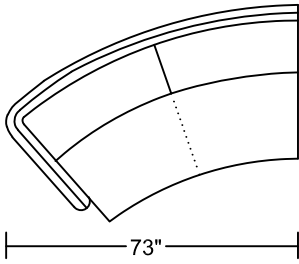

4BL/RAF

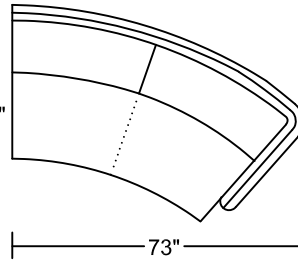

3BR/LAF

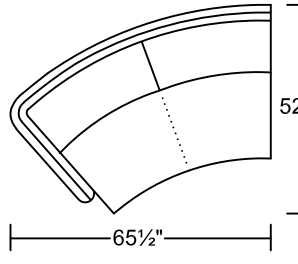

3BL/RAF

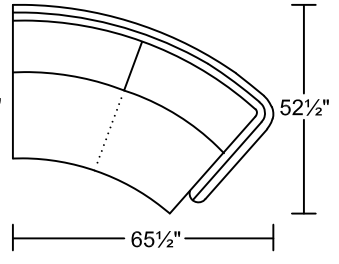

LUXR/LAF

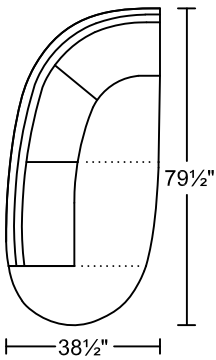

LUXL/RAF

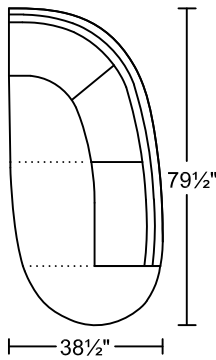

2.5BR/LAF

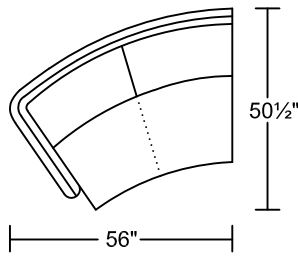

2.5BL/RAF

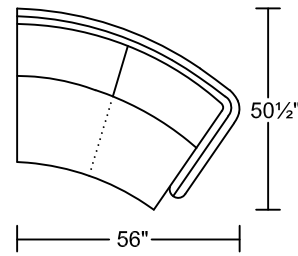

ST2

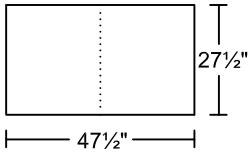

ST2

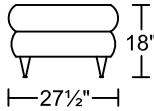

ST1

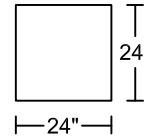

ST1

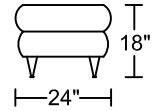

HR2

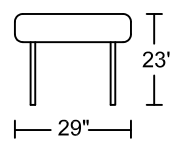

HR1

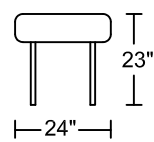

STG1

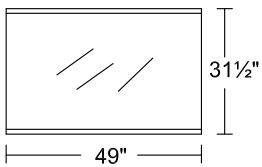

STG1

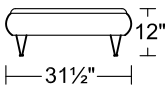

RT2

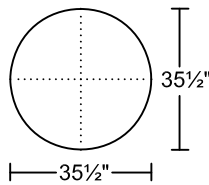

RT2

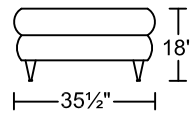

RT1

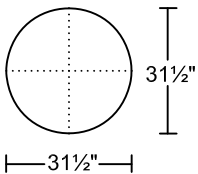

RT1

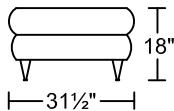

RTG1

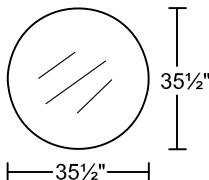

RTG1

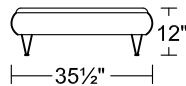

FRECCIA II 0541A-H1

Designed by Kelvin Ng

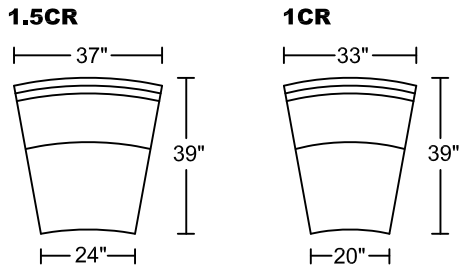
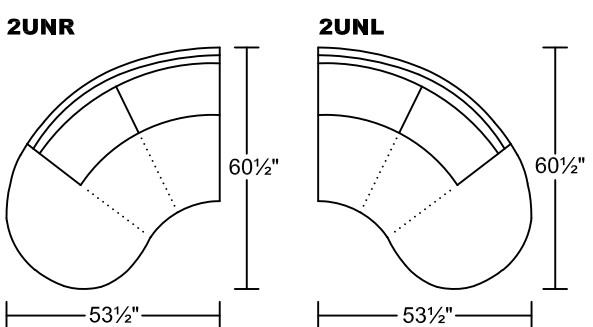
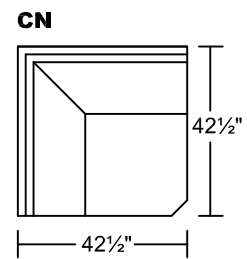
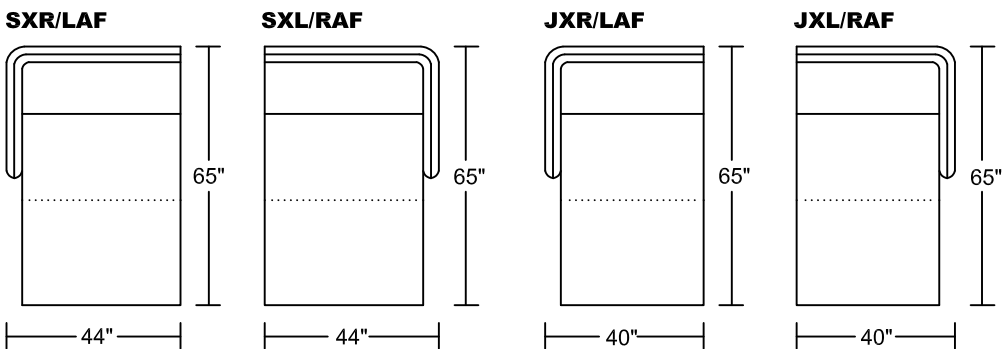
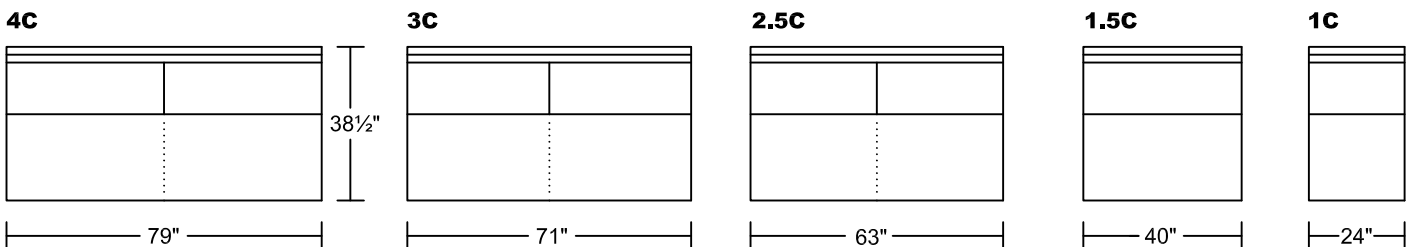
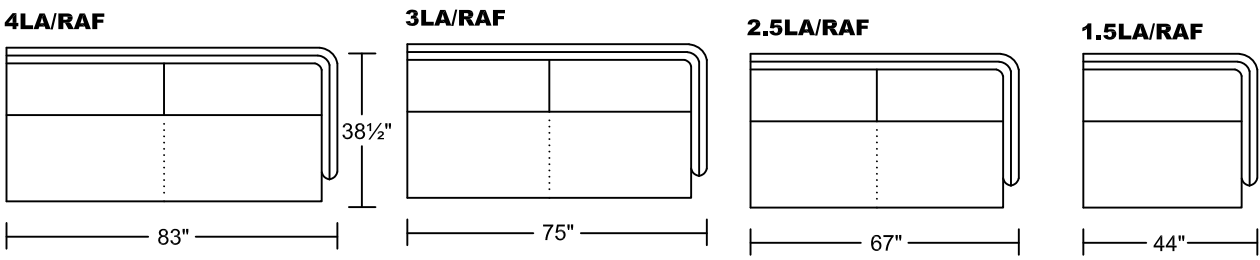
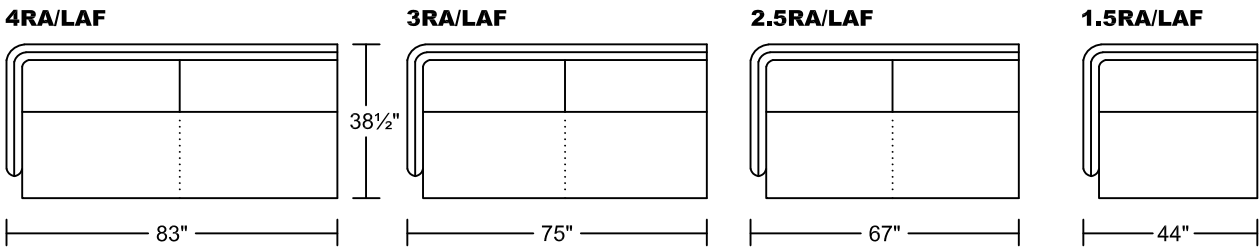
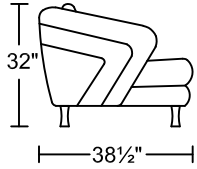
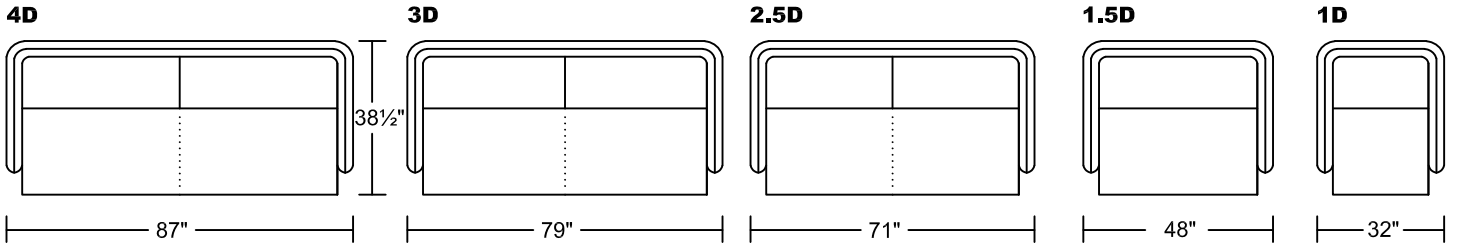

FRECCIA II 0541A-H1

Designed by Kelvin Ng

4BR/LAF

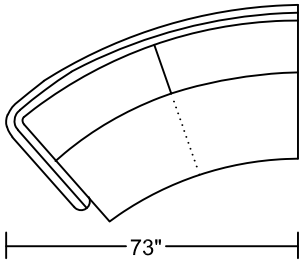

4BL/RAF

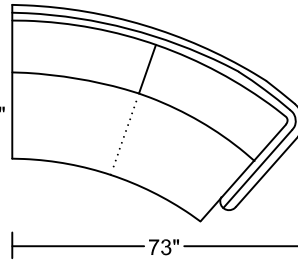

3BR/LAF

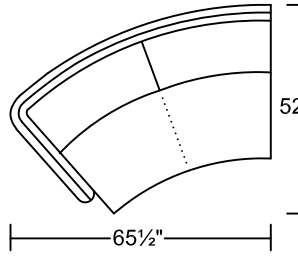

3BL/RAF

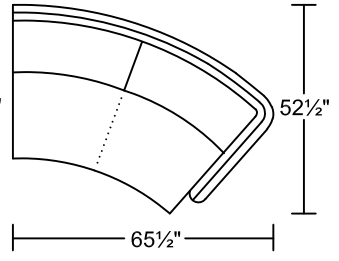

LUXR/LAF

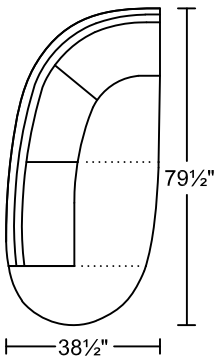

LUXL/RAF

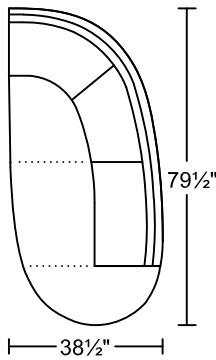

2.5BR/LAF

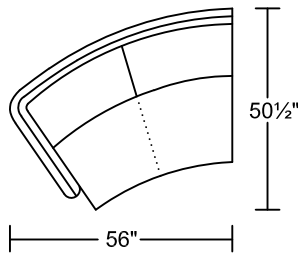

2.5BL/RAF

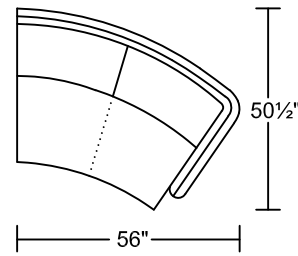

ST2

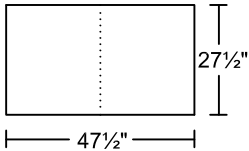

ST2

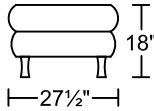

ST1

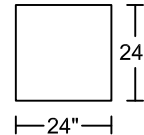

ST1

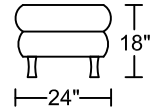

HR2

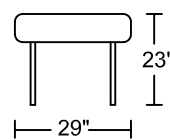

HR1

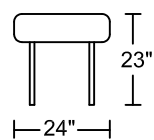

STG1

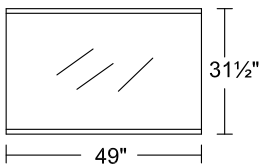

STG1

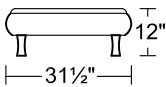

RT2

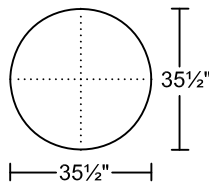

RT2

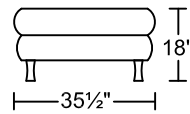

RT1

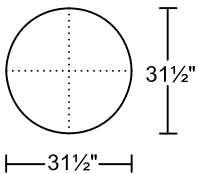

RT1

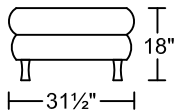

RTG1

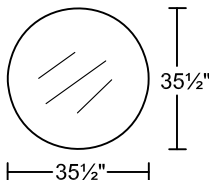

RTG1

